

Ambra 80 Pack 1

Features

- Complete Vanity Unit with Mirror
- Available in 4 Finishes: Glossy White, Nordic Oak, Anthracite, and Samara Ash
- Wall-hung design offers a clean, streamlined look
- Two soft close drawers with organizer in upper drawer
- Includes integrated sink and vanity top in gloss white ceramic with faucet hole and overflow
- Fully assembled structure and front made of engineered wood in wood finishes and high gloss lacquered
- Handle integrated in front of furniture
- Hidden hanging bracket directly assembled with great resistance and depth regulations
- Made in Spain







Related Items:

- WSBC 53991 | Push Waste Drain
- WSBC 53922 | Decorative Trap

SKU# | Options

- Ambra 80 Pack 1 NO | Nordic Oak
- Ambra 80 Pack 1 SA | Samara Ash
- Ambra 80 Pack 1 WG | Glossy White
- Ambra 80 Pack 1 AN | Anthracite









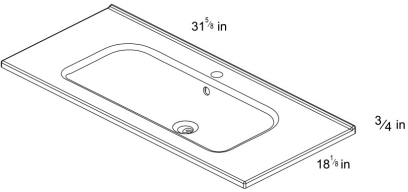

Finishes

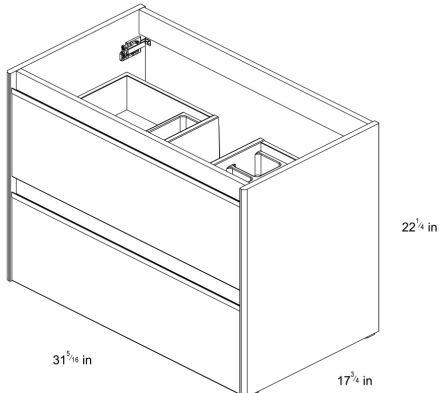
-  Nordic Oak
-  Samara Ash
-  Glossy White
-  Anthracite

* WS Bath Collections reserves the right to revise dimensions or information on this sheet without notice

Collection Ambra	Model Ambra 80 Pack 1	Dimensions Metric <i>1 inch = 2.54 cm</i> <i>1 inch = 25.4 mm</i>	 1051 Lea Drive - Collegeville, PA 19426 Tel. 215 513 9400 - Fax 610 831 0215 www.ws bathcollections.com - info@ws bathcollectins.com
----------------------------	-----------------------------------	---	---

Technical features

Technical drawing	Name	Material	Colour	Colour
	SLIM			Gloss White
	AMBRA 2 Drawers	   	   	Nordic Oak Samara Ash Gloss White Anthracite

Technical information

STRUCTURE	MDF board in 5/8 in. continuous wrapping in 2D/ Cyclum Process.
FRONT	MDF board in 5/8 in. continuous wrapping in 2D/ Cyclum Process.
HANDLE	Integrated in the front of the furniture.
DRAWER	Drawers made in mokka textile poly laminate coated board with hidden partial extraction runners with soft close system. Includes organizer in upper drawer. Lower drawer useful space (widthxhighxdepth): 27 ^{15/16} x 4 ^{57/16} x 12 ^{27/4} in.
WALL HANGING BRACKET	Hidden hanging bracket of directly assembled with great resistance and depth regulations.
LEGS	Metallic in bright chrome finish. (optional)
PIPE DEPTH	Pipe depth 2 ^{1/54} in.

Collection
Ambra

Model |
Ambra 80

Dimensions Metric

1 inch = 2.54 cm
1 inch = 25.4 mm

WS[®]
BATH
COLLECTIONS

1051 Lea Drive - Collegeville, PA 19426
Tel. 215 513 9400 - Fax 610 831 0215

www.ws bathcollections.com - info@ws bathcollections.com

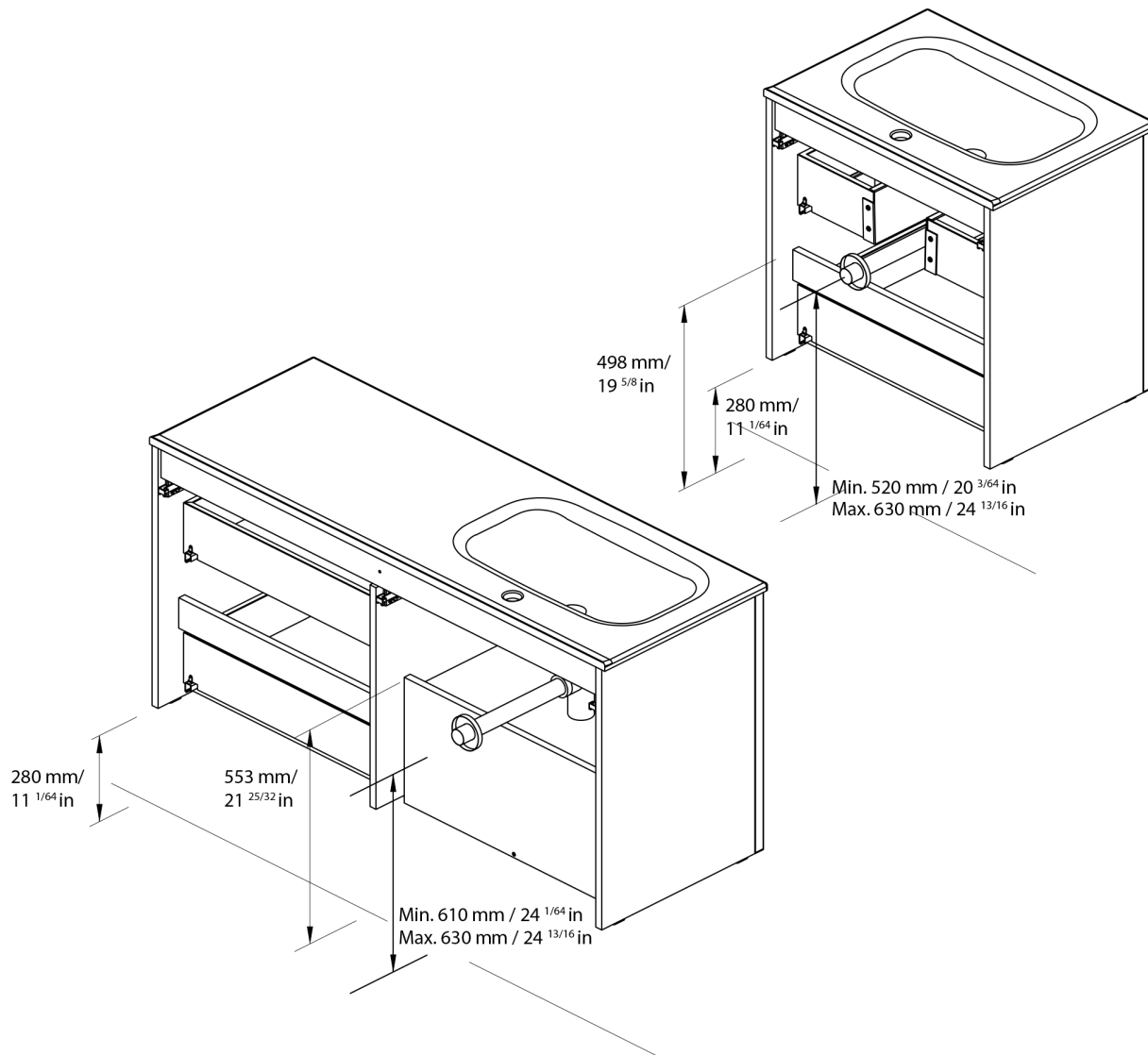

ES

EN

Las cotas indicadas en los dibujos son en función de la altura de la pata del conjunto, en caso de que el mueble vaya suspendido y esta altura no se respete, dichas cotas también variarán.

Dimensions indicated in the drawing are based on the level of the whole leg, in case of wall hanging the furniture dimensions also may vary.

Collection
Ambra

Model |
Ambra 80

Dimensions Metric

1 inch = 2.54 cm
1 inch = 25.4 mm

WS[®]

BATH
COLLECTIONS

1051 Lea Drive - Collegeville, PA 19426

Tel. 215 513 9400 - Fax 610 831 0215

www.ws bathcollections.com - info@ws bathcollections.com

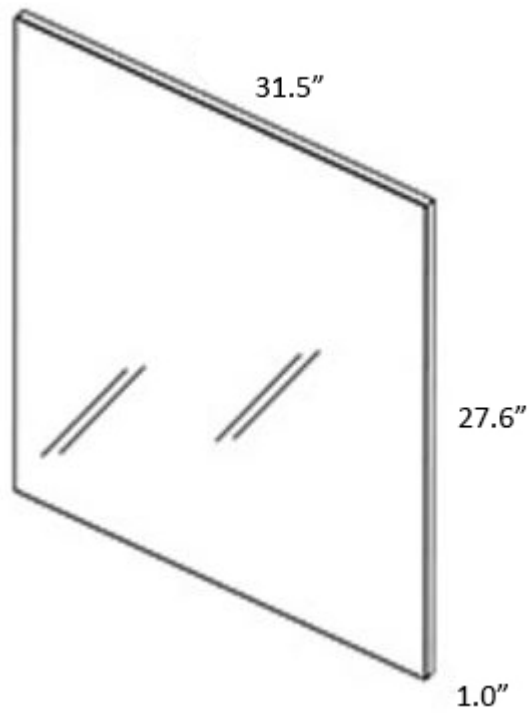

Collection
Murano

Model |
Murano 80

Dimensions Metric
1 inch = 2.54 cm
1 inch = 25.4 mm

WS[®]
BATH
COLLECTIONS

1051 Lea Drive - Collegeville, PA 19426
Tel. 215 513 9400 - Fax 610 831 0215
www.ws bathcollections.com - info@ws bathcollections.com

We recommend the following items that work with your sink.

TRAPS



WSBC 53922
Our best seller

DRAINS



WSBC 53991
Push waste drain (click clack)
with overflow

MOUNTING HARDWARE

Wall-mount installation

Vessel/ countertop installation



Bolts



Silicone (*optional*)

Collection
Ambra

Model |
Ambra 80 Pack 1

Dimensions Metric
1 inch = 2.54 cm
1 inch = 25.4 mm



1051 Lea Drive - Collegeville, PA 19426
Tel. 215 513 9400 - Fax 610 831 0215
www.ws bathcollections.com - info@ws bathcollections.com